

# serenelife<sup>8</sup>™



Dual Shot Basketball Arcade Game  
Indoor/Outdoor Two-Player Basketball System  
with One Audio Options, 8 Different Games  
and Large LED Scoreboard

**USER GUIDE**

**IMPORTANT! PLEASE READ THESE ASSEMBLY INSTRUCTIONS  
IN ENTIRETY BEFORE ASSEMBLING YOUR PRODUCT.**















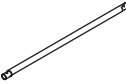

**⚠️ WARNING**

**CHOKER HAZARD: THIS TABLE CONTAINS SMALL BALLS AND PARTS  
NOT SUITABLE FOR CHILDREN UNDER 3 YEARS OF AGE.**



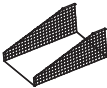
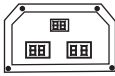
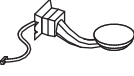



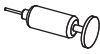
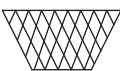



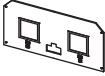



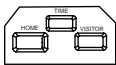
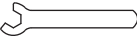

**⚠️ WARNING:**

1. Require 3pcs AA Batteries (Not included).
2. Do not mix old and new batteries.
3. Do not mix alkaline, standard (carbon zinc), or rechargeable (nickel-cadmium) batteries.

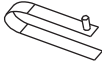
**PARTS LIST**

1  Board L Tube 2pcs	2  Board Tube 2pcs	3  Left Tube 1pc	4  Right Tube 1pc	5  Left L Tube 1pc
6  Right L Tube 1pc	7  Support Tube 2pcs	8  Mounting Tube 2pcs	9  Ramp Tube 2pcs	10  Ramp L Tube 2pcs
11  Ramp U Tube 1pc	12  Horizontal Tube 2pcs	13  Ball Ramp with Side Netting 1pc	14  Electronic Scorer 1pc	15  Switch Sensor 2pcs
16  Allen Key 1pc	17  Rim 2pcs	18  Rim Support Plate 2pcs	19  Inflation Pump with Needle 1pc	20 Pre-installed  Net 2pcs

## PARTS IDENTIFIER

21  Backboard 1pc	22  M6 Washer 46pcs	23  M6 x 20mm Bolt 16pcs	24  M6 x 29mm Bolt 6pcs	25  M6 x 42mm Bolt 4pcs
26  M6 x 50mm Bolt 4pcs	27  M6 Nut 32pcs	28  Basketball 7" Dia. 4pcs	29  3.5 x 10mm Bolt 4pcs	30  Electronic Scorer Face Plate 1pc
31  Wrench 1pc	32  M6 x 35mm Bolt 2pcs	33 Pre-installed  Lock Pin 2pcs	34 Pre-installed  Spring Lock 9pcs	35 Pre-installed  Plastic Pole Insert 2pcs
36  Control Box 1pc	37  Control Wire 1pc	38  4 x 28mm Bolt 2pcs	39  Self - Stick Strap 2pcs	

## ASSEMBLY INSTRUCTIONS

- Find a clean, level place to begin the assembly of your Basketball Game.  
We recommend that two adults work together to assembly this basketball game.
- Remove all the parts from the box and verify that you have all of the listed parts as shown on the Parts List. Carefully cut or tear the four corners of the box so that the bottom of the box can be used as your work surface.

### FIG. 1 & 2

- Attach the Board Tubes (#2) to the Left Tube (#3) and Right Tube (#4) using spring lock as shown in FIG.1.
- Attach the Support Tubes (#7) to the Mounting Tubes (#8) using spring lock as shown in FIG.2

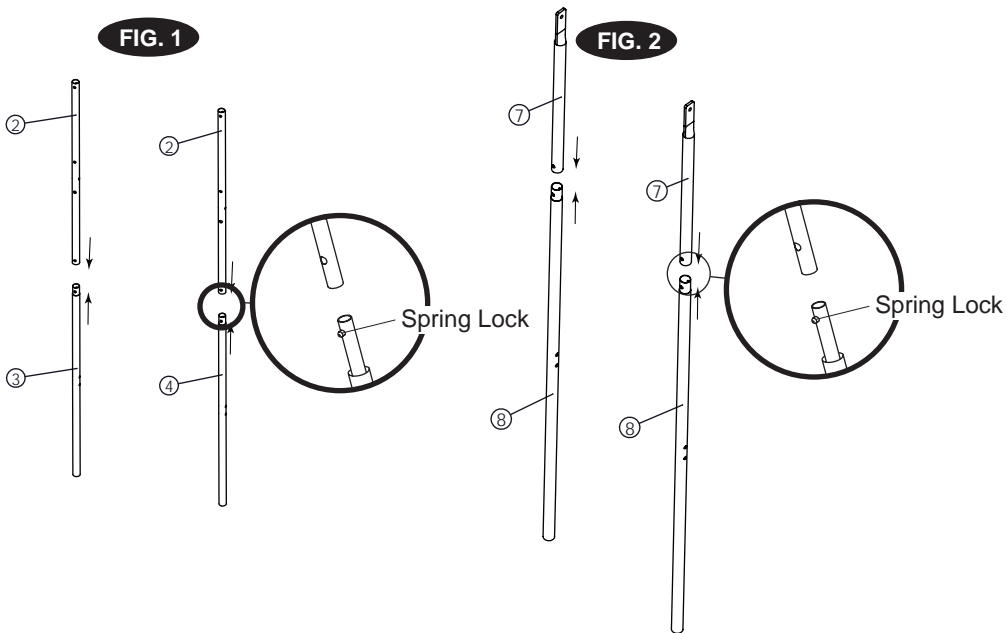

**FIG. 3**

5. Attach the Left L Tube (#5) and Right L Tube (#6) together using spring lock as shown in FIG.3

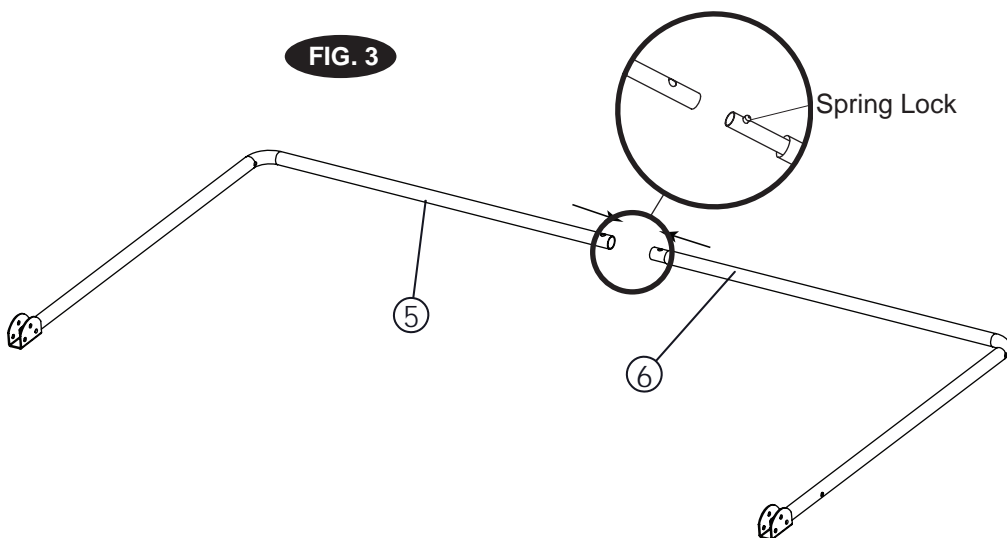

## FIG. 4

6. Attach the Left and Right L Tubes (#5 and #6) to Left and Right Tubes (#3 and #4) using Bolts(#26), Washers (#22) and Nuts (#27), and then attach the Left and Right L Tube (#5 and #6) to the Mounting Tube (#8) using Bolts (#26), Washers (#22) and Nuts (#27) as shown in FIG. 4A & 4B.
7. Attach the Support Tube and Mounting Tube (#7 and #8) to the Board Tube (#2) using Bolts (#24), Washers (#22) and Nuts (#27) as shown in FIG. 4C, repeat this step for other side.

**Note:** Make sure the spring lock is face down.

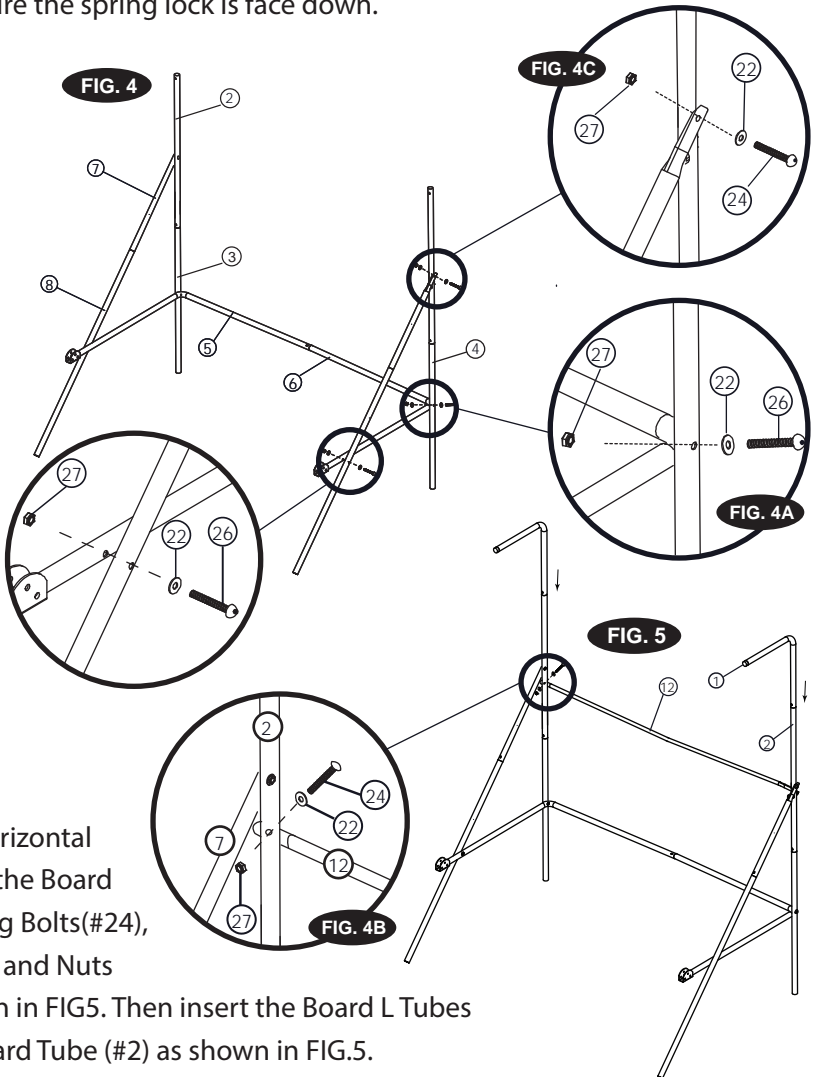

## FIG. 5

8. Attach the Horizontal Tube (#12) to the Board Tube (#2) using Bolts(#24), Washers (#22) and Nuts (#27) as shown in FIG5. Then insert the Board L Tubes (#1) to the Board Tube (#2) as shown in FIG.5.

## FIG. 6 & 7

9. Attach the Ramp Tubes (#9) to the Left and Right L Tubes (#5 and #6) using Bolts (#32), Washers (#22) and Nuts (#27) as shown in FIG 6.
10. Attach the Ramp L Tubes (#10) to Ramp U Tube (#11) using spring lock, and then place the Ramp L Tube (#10) to the Ramp Tube (#9) using spring lock as shown in FIG.7.

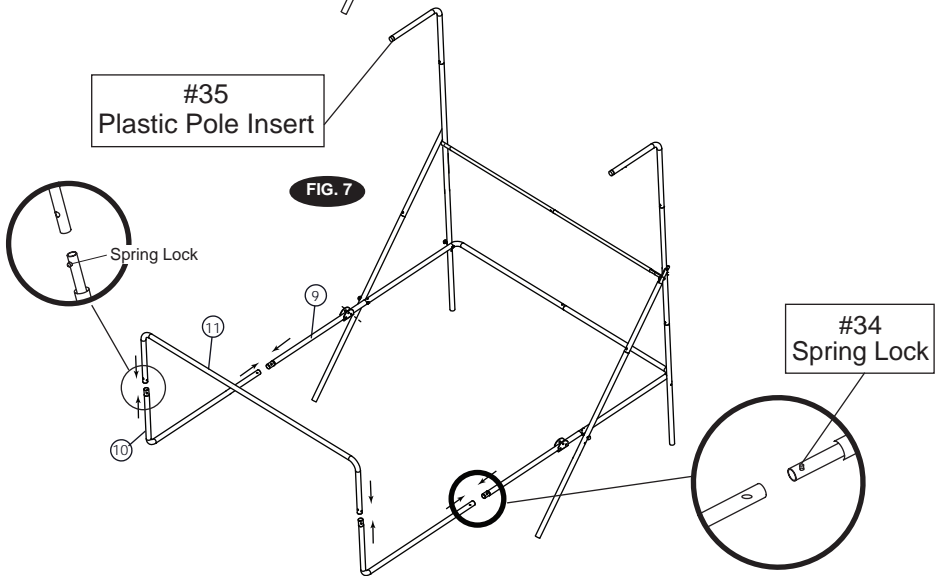
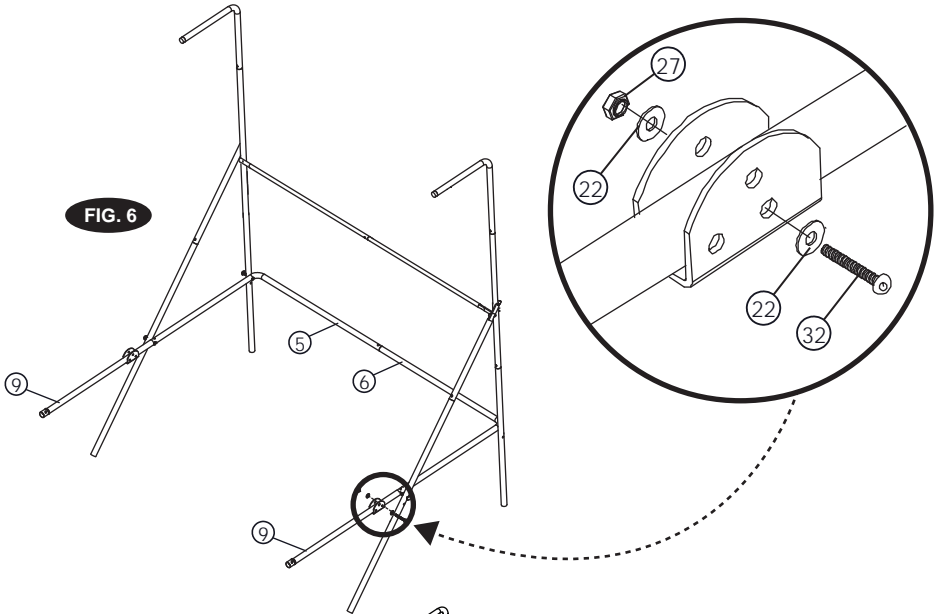

## FIG. 8 & 9

11. Attach the Rim Assemblies (#17) and Rim Support Plates (#18) to the Backboard (#21) using the Bolts (#23), washers (#22) and Nuts (#27). And then attach the Switch Sensor (#15) to the Backboard (#21) using the Bolts (#23), washers (#22) and Nuts (#27). Make sure that you use washer on both sides of the backboard as shown in FIG. 8.
12. Attach Electronic Scorer Face Plate (#30) to Backboard and connect with the Electronic Scorer (#14) using Bolts (#29) as shown in FIG. 9.

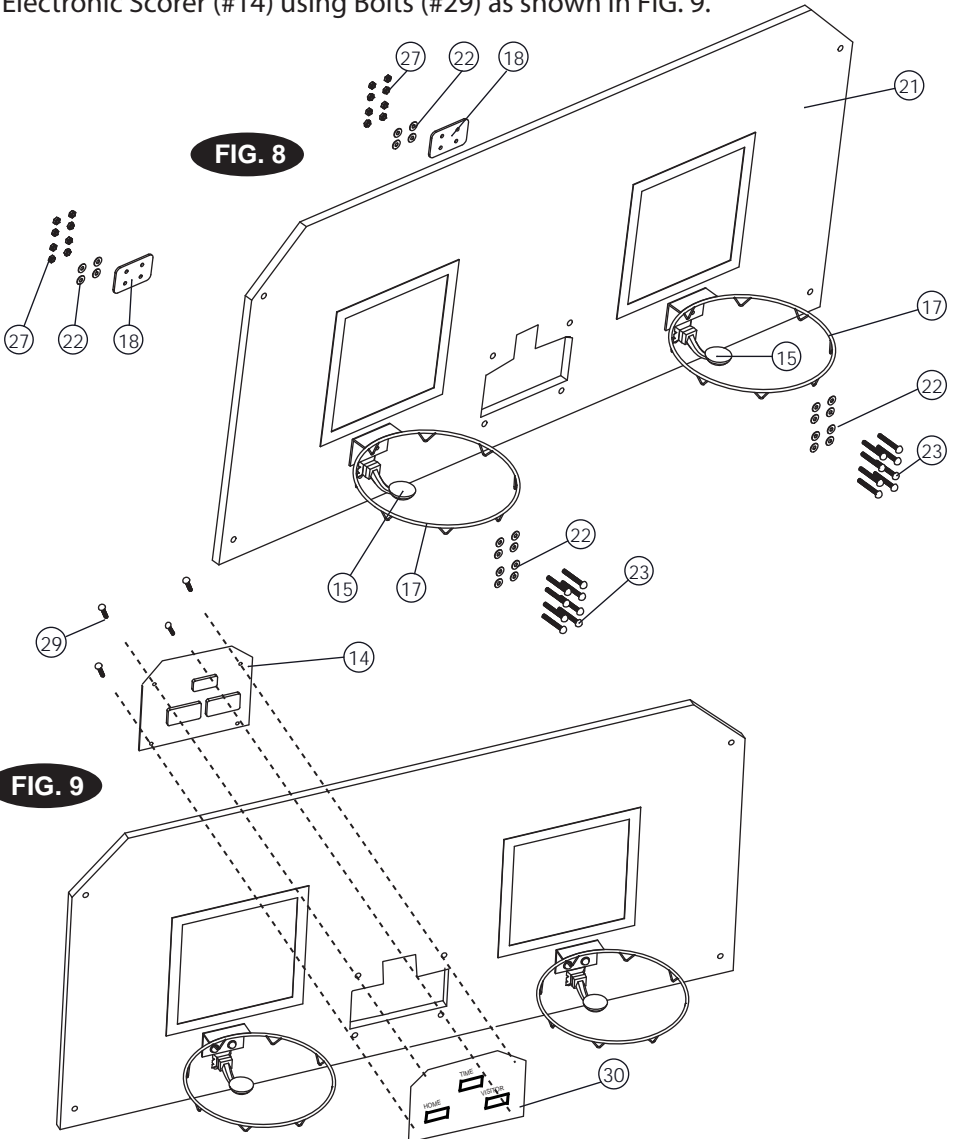

**FIG. 10**

13. Slide elastic straps and sleeve of Ball Ramp with Side Netting (#13) onto Board Tubes as shown in FIG. 10A & 10B & 10C.

14. Slide the Horizontal Tube (#12) in front of the Ball Ramp with Side Netting (#13) and attach it to the Ramp U Tube (#11) using Bolts (#24), Washers (#22) and Nuts (#27) as shown in FIG.10D.

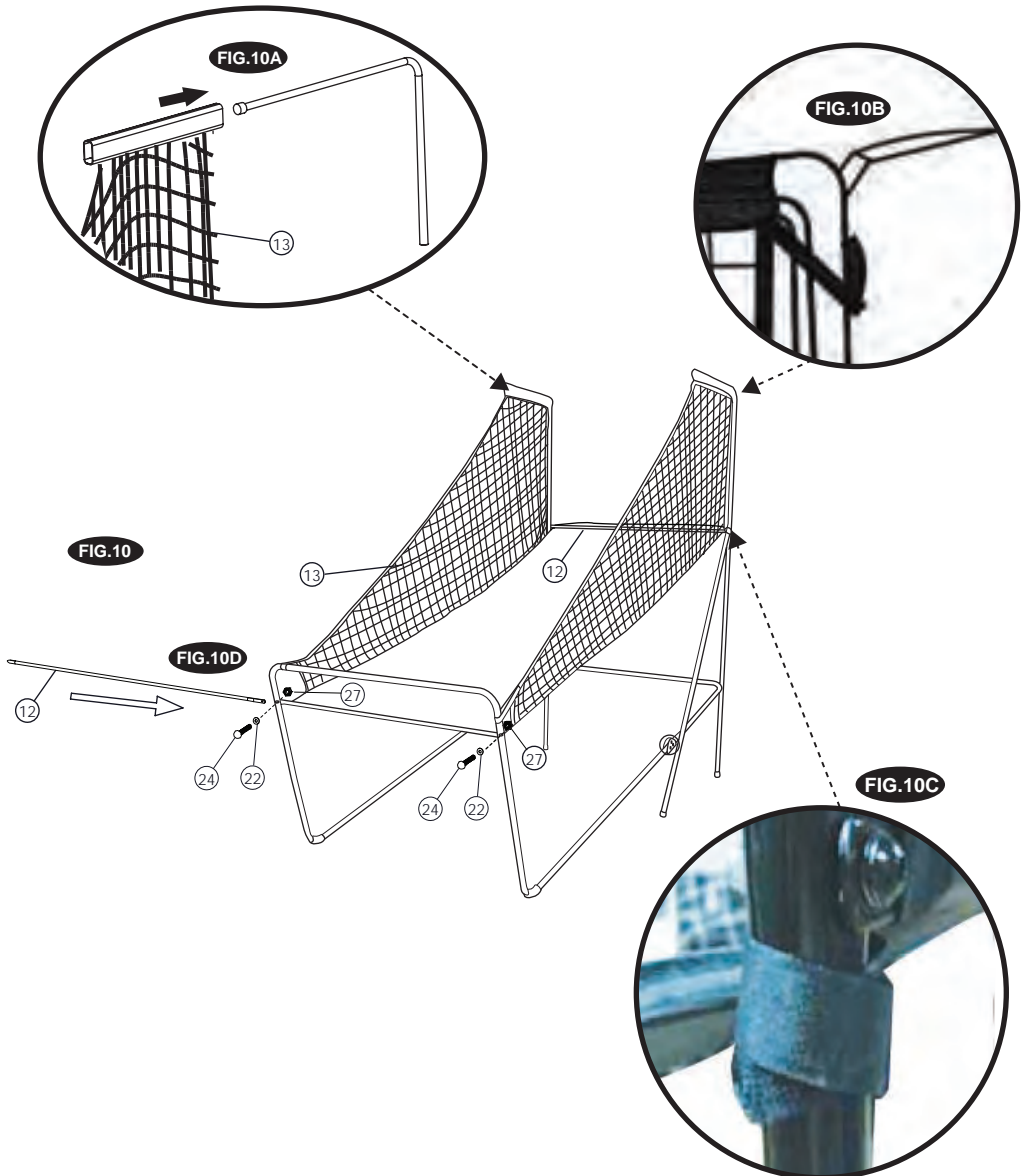



**FIG. 11**

15. With the help of another adult, Attach the Backboard (#21) to the Board Tubes (#1) using Bolts (#25), Washers (#22) and Nuts (#27) as shown in FIG.11 A.  
At each bottom hole of the backboard, attach the ramp tabs of Ball Return with Netting (#13) using Bolts (#25), Washers (#22) and Nuts (#27) as shown in FIG.11 B.
16. Insert the Lock Pins (#33) to the Left and Right L Tubes (#5 and #6) as shown in FIG. 11 C.

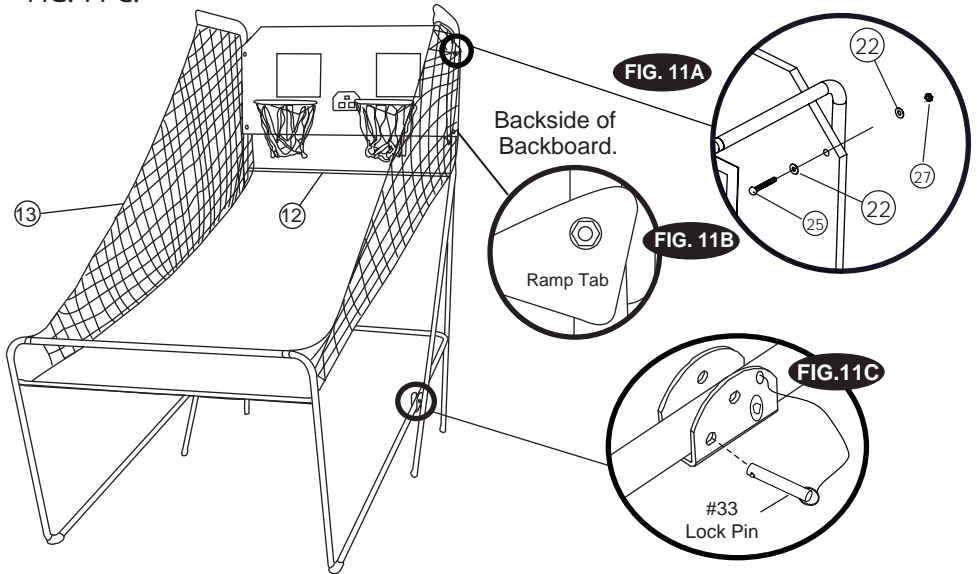

**FIG. 12**

17. Connect the Sensor Wire of Switch Sensor to the Electronic Scorer (#14) as shown in FIG. 12. Connect the Control Wire (#37) to the Electronic Scorer (#14) as shown in FIG.12 and 12A.

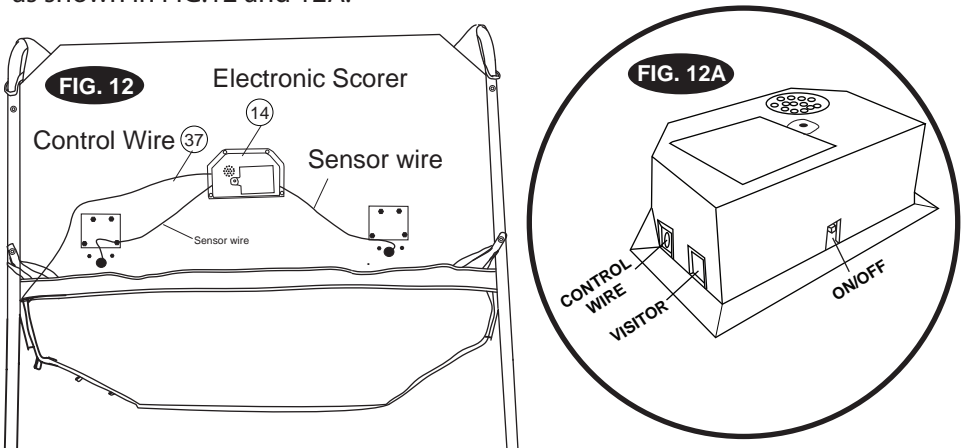

**FIG. 13**

18. Attach the Control Box (#36) to middle of the Ramp U Tube (#11) using two Bolts (#38) as shown in FIG.13 A.
19. Run the rest of the Control Wire (#37) through the loops on the Ball Return with Side Netting (#13) and plug it into the Control Box (#36). Place the Control Wire (#37) on the Ramp U Tube (#11) using the Self - Stick Straps (#39) as shown is FIG.13 B.

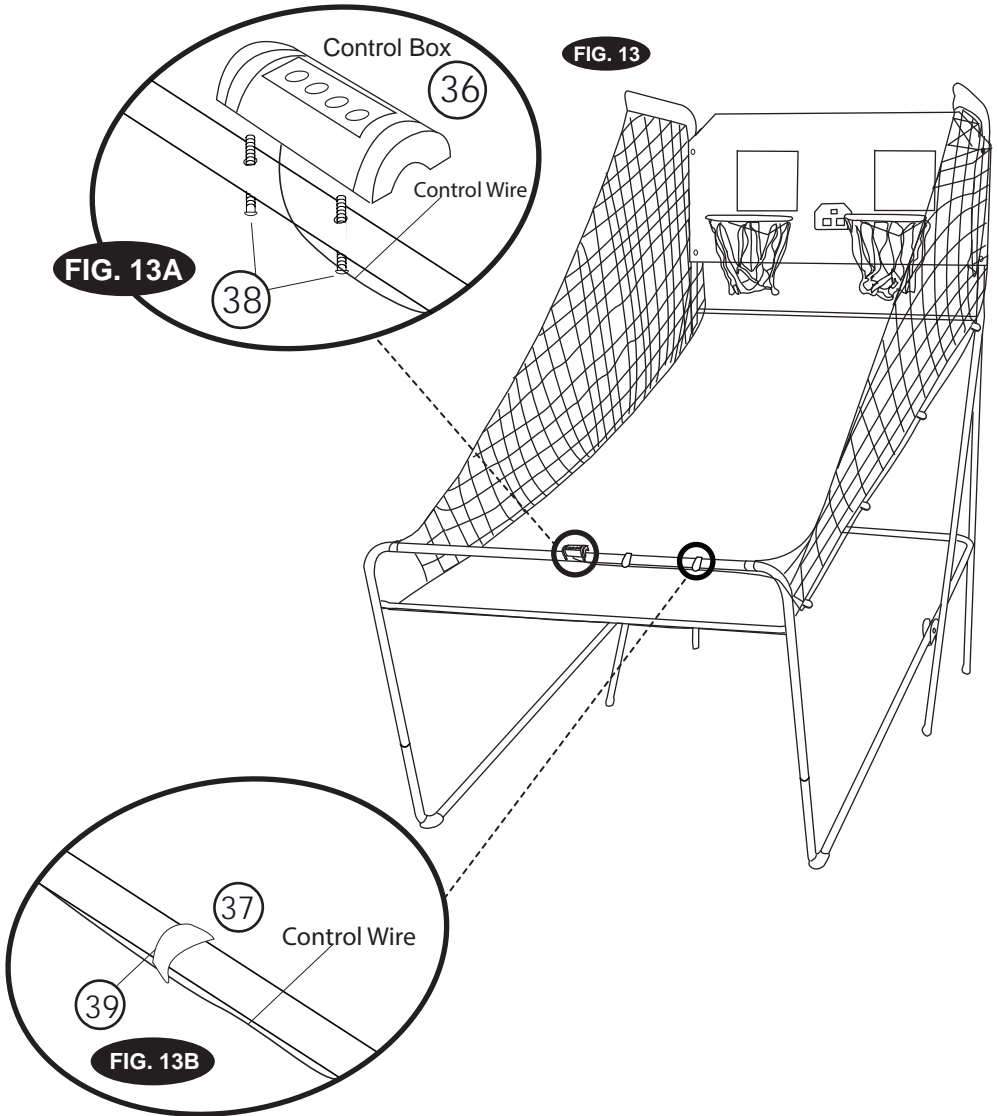

**FIG. 14**

20. Folding position when not in use the basketball game and insert the Lock Pin (#33) as shown in FIG 14.

**Note:** The lock pin (#33) needs to be removed from its original position when the game is being used before insertion to the new position when folded.

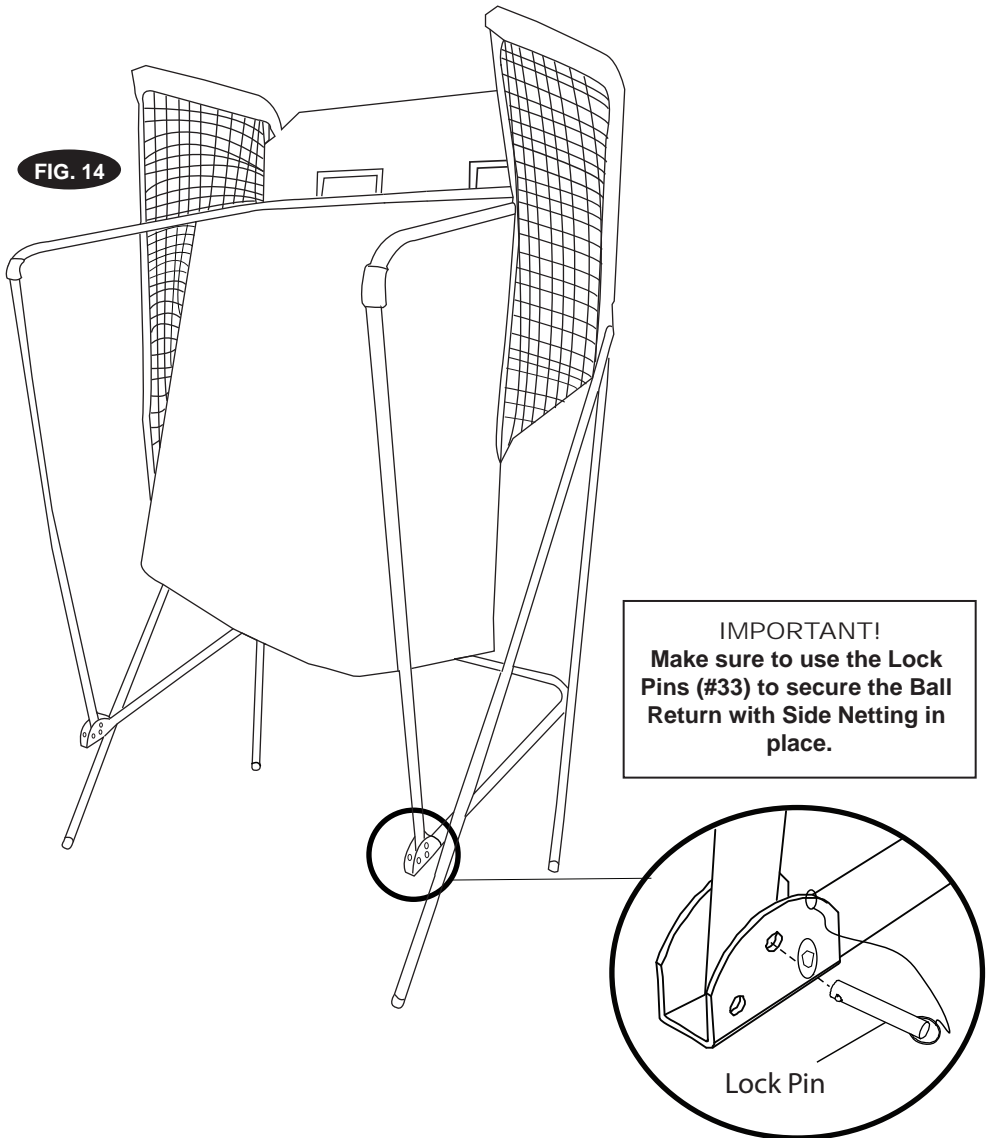

## ELECTRONIC SCORER OPERATION

### Installing Batteries:

Using a screwdriver, unscrew lid and open the battery box. Insert 3 "AA" batteries (not included) in the order of polarity as shown on the inside cover. Close the cover and tighten screw. Turn the power ON using the ON/OFF switch. if the game will not be used for a long period of the time, we recommend that the batteries should be removed.

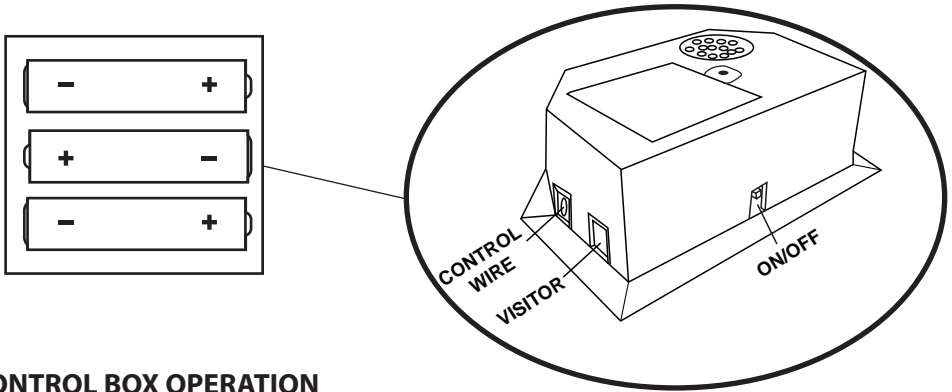

### CONTROL BOX OPERATION

- Press "ON/OFF" to activate the scorer.
- Scoreboard "HOME" shows "01" (pre- set game 1).
- Press "SELECT UP and DOWN" to select a game.
- Press "SELECT UP and DOWN" to enter selected game mode.
- Press "SOUND" to switch sound ON/OFF while playing.
- Press "PAUSE" to pause or start time counting.
- Press and hold the button "ON/OFF" 3 seconds to turn off scorer.
- Press and hold the button "RESET" 3 seconds to reset the games.

**Note:** If no shot is made or no button is pressed in 15 mins, scorer will be turned off automatically.

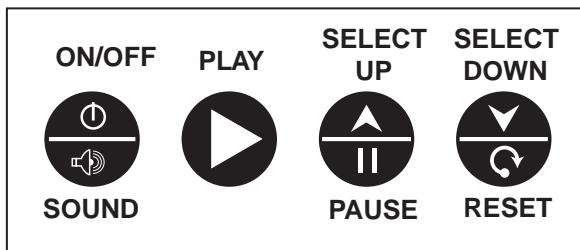

CONTROL PANEL

## CHOOSE FROM 8 DIFFERENT GAME OPTIONS

### 1. Beat the time Clock

- Press "PLAY" to enter game 1.
- Press "UP/Down" to select single/multiple players (P1/P2/P3/P4).
- Press "PLAY" after the number of player is selected.
- Press "UP/Down" to select playing time, 30/45/60 seconds.
- Press "PLAY" to begin the game.
- Scoreboard "HOME" shows Player 1, 3; Scoreboard "VISITOR" shows Player 2, 4.
- All shots worth 2 points until last 10 seconds, each score counts 3 points.
- Countdown 5 seconds to next player's turn when one player finishes game.
- Player with more points scored wins (LED will flash on player with higher score).
- Press "PLAY" to restart this game.

### 2. 3 Point Beat the Time Clock

- Press "PLAY" to enter game 2.
- Press "UP/Down" to select single/multiple players (P1/P2/P3/P4).
- Press "PLAY" after the number of player is selected.
- Press "UP/Down" to select playing time, 30/45/60 seconds.
- Press "PLAY" to begin the game.
- Scoreboard "HOME" shows Player 1, 3; Scoreboard "VISITOR" shows Player 2, 4.
- All shots made count 3 points.
- Countdown 5 seconds to next player's turn when one player finishes game.
- Player with more points scored wins (LED will flash on player with higher score).
- Press "PLAY" to restart this game.

### 3. Battle Back

- Press "PLAY" to enter game 3.
- Press "UP/Down" to select playing time, 30/45/60 seconds.
- Press "PLAY" to begin the game.
- Shot made in "HOME" frame, +2 points scored display on "HOME" board and -2 points for "VISITOR".
- Shot made in "VISITOR" frame, +2 points scored display on "VISITOR" board and -2 points for "HOME".
- Once a player scores 10 points who wins and game is finished.
- Press "PLAY" to restart this game.

#### 4. Horse

- Press "**PLAY**" to enter game.
- Press "**UP/Down**" to select multiple players (P2/P3/P4)
- Press "**PLAY**" after the number of player is selected
- Player has to make a shot in 2 seconds.
- First player is allowed to shoot at any hoop (Home or VISITOR). If first player scores in 2 seconds, no letter is given. Game continues for next player. Scoreboard will display "**next player (P2P3/P4)**" and LED will flash twice in a second. After flash, next player has to duplicate the shot in the same hoop selected by first player.
- If player can't score in 2 seconds, player receives the first letter "**H**" which will display on scoreboard. Game remains for the same player until the player scores. If player keeps missing, player receives "**O**" followed by "**R**", "**S**", "**E**". The letter "**E**" is given, the player is out.
- The first player to spell "**horse**" loses. Players stay in repeat step d.e.f. till game is finished
- The last player to spell "**horse**" wins
- Press "**PLAY**" to restart this game

#### 5. Check Point

- Press "**PLAY**" to enter game 5.
- Press "**UP/Down**" to select single/multiple players (P1/P2/P3/P4).
- Press "**PLAY**" to begin the game.
- "**HOME**" displays "**player**", "**VISITOR**" displays "**24**" points, pre-set 40 seconds playing time.
- Points scored will display on scoreboard "**HOME**".
- Before time is out, once 24/52/68/86 points is scored, playing time increases 10/20/10/20 seconds respectively
- Countdown 5 seconds to next player's turn when one player finishes game.
- Player with more points scored wins ( LED will flash on player with higher score)
- Game is finished when a player scores 99 points
- Press "**PLAY**" to restart this game

## 6. Around the World

- Use tape to mark the shooting lines.
- Press "**PLAY**" to enter game 6.
- Press "**UP/Down**" to select single/multiple players (P1/P2/P3/P4).
- Press "**PLAY**" after the number of player is selected.
- Scoreboard "**HOME**" displays Player 1/2/3/4, "**VISITOR**" displays scored points.
- Once score comes to 14 points or time comes to 99 seconds countdown 5 seconds to next player's turn when one player finishes game.
- Player who finishes the game first wins (LED will flash on winner).
- Press "**PLAY**" to restart this game.

## 7. Left and Right shoot

- Press "**PLAY**" to enter game 7.
- Press "**UP/Down**" to select single/multiple players (P1/P2/P3/P4).
- Press "**PLAY**" after the number of player is selected.
- Press "**UP/Down**" to select playing time, 30/45/60 seconds.
- Press "**PLAY**" to begin the game.
- Scoreboard "**HOME**" displays Player, "**VISITOR**" displays points.
- Make a shot in "**HOME**" frame when LED is flashing on "**HOME**", 2 points scored display on "**HOME**".
- Make a shot in "**VISITOR**" frame when LED is flashing on "**VISITOR**", 2 points scored display on "**VISITOR**".
- Countdown 5 seconds to next player's turn when one player finishes game.
- Player with more points scored wins (LED will flash on player with higher score).
- Press "**PLAY**" to restart this game.

## 8. One to One

- Press "**PLAY**" to enter game 8.
- Press "**UP/Down**" to select playing time, 30/45/60 seconds.
- Press "**PLAY**" to begin the game.
- Shot made in "**HOME**" frame, 2 points scored for "**HOME**", all shots count 3 points in last 10 seconds.
- Shot made in "**VISITOR**" frame, 2 points scored for "**VISITOR**", all shots count 3 points in last 10 seconds.
- Player with more points scored wins when time is out.
- Press "**PLAY**" to restart this game.

serenelife™

***Questions? Issues?***

We are here to help!

Phone: (1) 718-535-1800

Email: [support@pyleusa.com](mailto:support@pyleusa.com)